



**Ultraflacher Bühnenmonitor mit koaxial angeordneter 15" Neodym / 1.4" Neodym Bestückung. Hohe Leistungsreserven, homogene Schallverteilung und geringe Rückkopplungsneigung machen den M 3 zu einem Werkzeug, welches die Arbeit des Tontechnikers sehr erleichtert. In Verbindung mit dem Flugbügel kann der M 3 auch als Downfill oder universelles Beschallungssystem eingesetzt werden.**

## PRODUCT SPECIFICATIONS

<b>Speaker Components</b>	15" Nd / 1,4" Nd Coaxial
<b>Description</b>	Low Profile Monitor
<b>Power</b> AES / Peak	500 W / 1500 W
<b>Impedance</b> nominal	8 Ω
<b>SPL</b> 1 W / Peak @ 1 m	99 dB / 134 dB
<b>Usable Range</b>	65 Hz - 19 kHz (- 6 dB)
<b>Tuning Frequency</b> excursion minimum	70 Hz
<b>X - Overpoint</b> acoustical	1 kHz
<b>Coverage</b> horizontal / vertical	60° - conical
<b>Max. Splay Angle</b>	- - -
<b>Connectors</b>	2 x Neutrik Speakon NL4MP in/out Coding: 1 +/- HiMid, 2 +/- loop thru
<b>Handles</b>	2 x
<b>Rigging / Fittings</b>	2 x M10
<b>Weight</b>	18 kg
<b>Size</b> height x width x depth	30,9 x 45,0 x 54,0 cm
<b>Order No.</b>	<b>01067</b>



Die formschönen Griffe garantieren ein komfortables Handling des Monitors.



Die Anschlüsse liegen gut zugänglich dem Nutzer zugewandt.



## DIMENSIONS

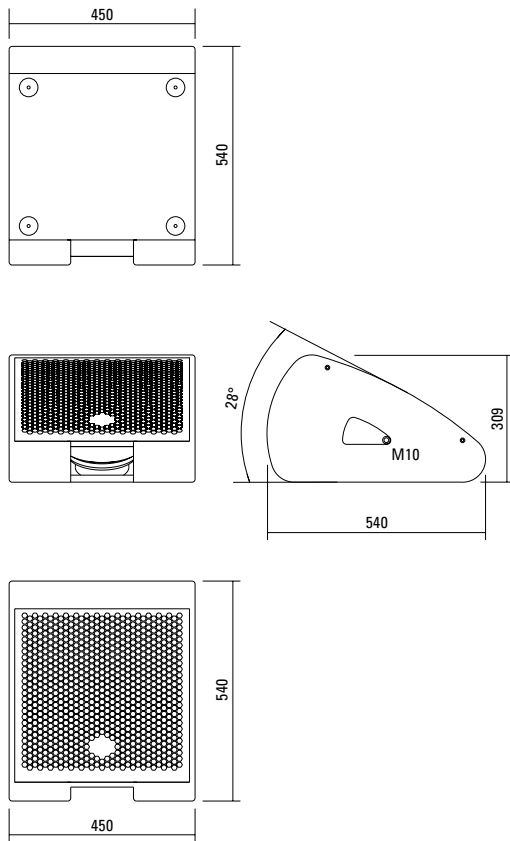

## MEASUREMENTS

### Sensitivity 1 W @ 1 m + Impedance

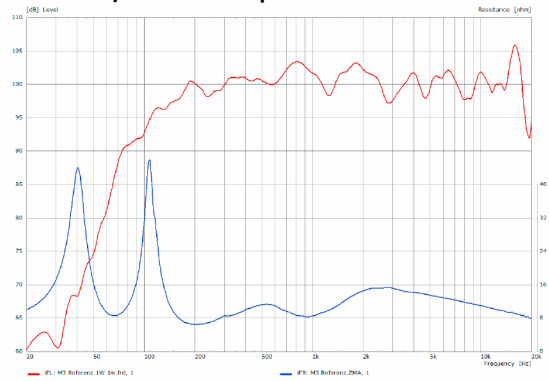

### 2D Directivity Plot - horizontal-vertical

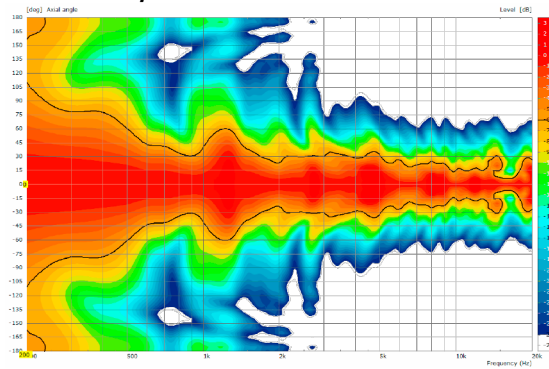

### Controller Setups:



<https://www.seeburg.net/de/downloads>

## APPLICATIONS

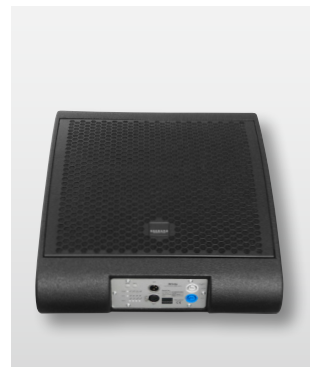
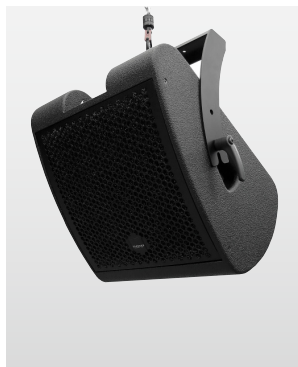
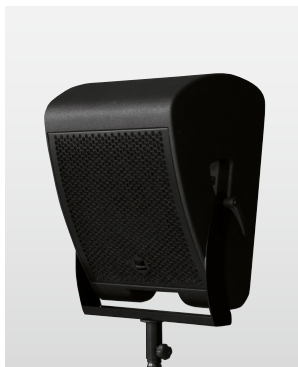

## ACCESSORIES M 3

### Flying Bracket



for M 3  
incl. screws  
(per unit: 2 pcs. M10 x 60 adjustable  
handle screws)  
Order No. **01218**

### Handle Screw



for flying brackets, adjustable  
M10 x 60  
Order No. **08375/60**

### Knurled Head Nut



reduction screw for fastening  
M10 Pole Mount Adapter (08126)  
Order No. **73755**

### Pole Mount Adapter



35 mm  $\varnothing$   $\rightarrow$  M10 x 16 mm,  
M8 x 20 star knob screw  
Order No. **08126**

### Quick Trigger Clamp



max. load 100 kg  
Order No. **01223/100 kg**

### Quick Trigger Clamp - small



M10, max. load 20 kg  
Order No. **01223/20 kg**

### Ring Screw



M10– DIN 580  
Order No. **73700** (zincd)  
Order No. **73700/sw** (black zincd)

### TV Spigot



10 mm internal thread,  
28 mm  $\varnothing$   
Order No. **08128**

### Steel Safety



6 mm x 600 mm, black,  
max. load 22 kg (BGI 810-3),  
quick connector undetachably  
Order No. **01376/6**

### Chain Fastener



VBS 7 mm  
Order No. **01378**

### Rain Cover

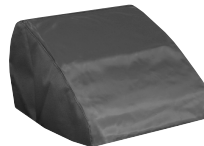

for M 3  
Order No. **01229/M3/outdoor**

### Flight Case



for 2 pcs. M 3  
heavy duty, 9 mm birch multiplex,  
PVC coated, hinged lid, 6 x recessed  
sprung handles, 2 x butterfly catches,  
4 x 100 mm blue wheels, 2 pcs. with  
brake, stackable, insert for flying  
bracket, interior lined with felt  
Order No. **16018/pro**