

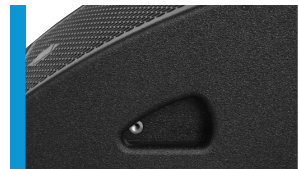

Ultraflacher Bühnenmonitor mit koaxial angeordneter 12" Neodym / 1.4" Neodym Bestückung. Hohe Leistungsreserven, homogene Schallverteilung und geringe Rückkopplungsneigung machen den M 1 zu einem Werkzeug, welches die Arbeit des Tontechnikers sehr erleichtert. In Verbindung mit dem Flugbügel kann der M 1 auch als Downfill oder universelles Beschallungssystem eingesetzt werden.

PRODUCT SPECIFICATIONS

Speaker Components	12" Nd / 1,4" Nd Coaxial
Description	Low Profile Monitor
Power AES / Peak	500 W / 1500 W
Impedance nominal	8 Ω
SPL 1 W / Peak @ 1m	98 dB / 133 dB
Usable Range	80 Hz - 19 kHz (- 6 dB)
Tuning Frequency excursion minimum	90 Hz
X - Overpoint acoustical	1,2 kHz
Coverage horizontal / vertical	60° - conical
Max. Splay Angle	- - -
Connectors	2 x Neutrik Speakon NL4MP in/out Coding: 1 +/- HiMid, 2 +/- loop thru
Handles	2 x
Rigging / Fittings	2 x M10
Weight	16 kg
Size height x width x depth	27,4 x 40,0 x 47,0 cm
Order No.	01068



Dezent und komfortabel:
Die Griffe des M 1.



Die Anschlüsse liegen gut zugänglich
dem Nutzer zugewandt.



DIMENSIONS

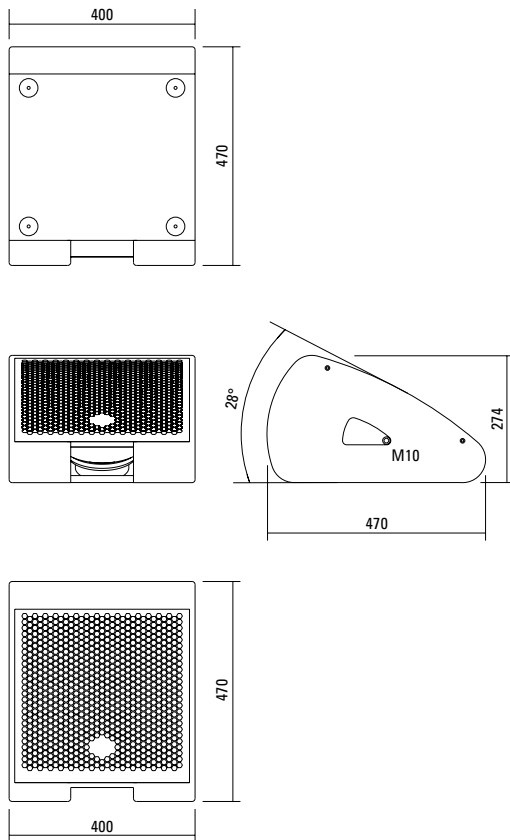

MEASUREMENTS

Sensitivity 1 W @ 1 m + Impedance

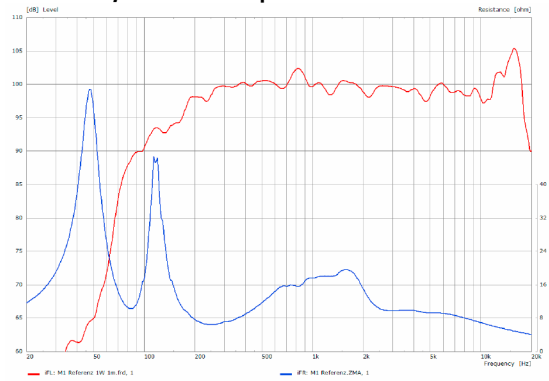

2D Directivity Plot - horizontal

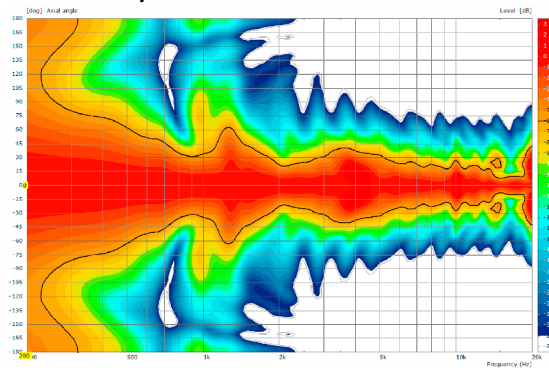

Controller Setups:



<http://www.seeburg.net/de/downloads>

APPLICATIONS

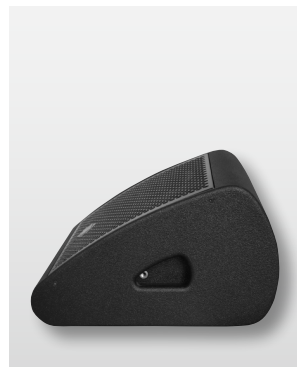
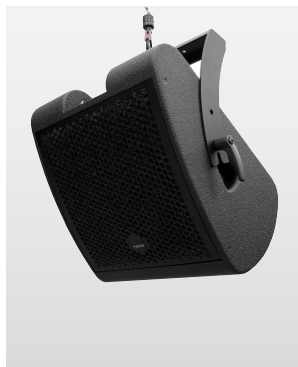

ACCESSORIES M 1

Flying Bracket



for M 1
incl. screws
(per unit: 2 pcs. M10 x 60 adjustable
handle screws)
Order No. **01202**

Handle Screw



for flying brackets, adjustable
M10 x 60
Order No. **08375/60**

Knurled Head Nut



reduction screw for fastening
M10 Pole Mount Adapter (08126)
Order No. **73755**

Pole Mount Adapter



35 mm \varnothing \rightarrow M10 x 16 mm,
M8 x 20 star knob screw
Order No. **08126**

Quick Trigger Clamp



max. load 100 kg
Order No. **01223/100 kg**

Quick Trigger Clamp - small



M10, max. load 20 kg
Order No. **01223/20 kg**

Ring Screw



M10– DIN 580
Order No. **73700** (zincd)
Order No. **73700/sw** (black zincd)

TV Spigot



10 mm internal thread,
28 mm \varnothing
Order No. **08128**

Steel Safety



6 mm x 600 mm, black,
max. load 22 kg (BGI 810-3),
quick connector undetachably
Order No. **01376/6**

Chain Fastener



VBS 7 mm
Order No. **01378**

Rain Cover

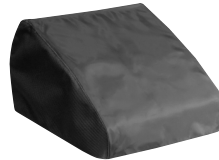

for M 1
Order No. **01228/outdoor**

Flight Case



for 2 pcs. M 1,
heavy duty, 9 mm birch multiplex,
PVC coated, hinged lid, 6 x recessed
sprung handles, 2 x butterfly catches,
4 x 100 mm blue wheels, 2 pcs. with
brake, stackable, interior lined with felt
Order No. **16015/pro**